

Pin-mapping for the various sizes of M8CC 194 adapter can be done.  
 The M8CC column is all the possible pins.  
 The blue column shows the number they map to the 40 pins.  
 In pin 4 of a 20-pin M8CC map to adapter pin 20.

M8CC M8PCC 20PCC M8CC 20PCC 20PCC 20PCC

M8CC	M8PCC	20PCC	M8CC	20PCC	20PCC	20PCC
1	1	1	1	1	1	1
2	2	2	2	2	2	2
3	3	3	3	3	3	3
4	4	4	4	4	4	4
5	5	5	5	5	5	5
6	6	6	6	6	6	6
7	7	7	7	7	7	7
8	8	8	8	8	8	8
9	9	9	9	9	9	9
10	10	10	10	10	10	10
11	11	11	11	11	11	11
12	12	12	12	12	12	12
13	13	13	13	13	13	13
14	14	14	14	14	14	14
15	15	15	15	15	15	15
16	16	16	16	16	16	16
17	17	17	17	17	17	17
18	18	18	18	18	18	18
19	19	19	19	19	19	19
20	20	20	20	20	20	20
21	21	21	21	21	21	21
22	22	22	22	22	22	22
23	23	23	23	23	23	23
24	24	24	24	24	24	24
25	25	25	25	25	25	25
26	26	26	26	26	26	26
27	27	27	27	27	27	27
28	28	28	28	28	28	28
29	29	29	29	29	29	29
30	30	30	30	30	30	30
31	31	31	31	31	31	31
32	32	32	32	32	32	32
33	33	33	33	33	33	33
34	34	34	34	34	34	34
35	35	35	35	35	35	35
36	36	36	36	36	36	36
37	37	37	37	37	37	37
38	38	38	38	38	38	38
39	39	39	39	39	39	39
40	40	40	40	40	40	40

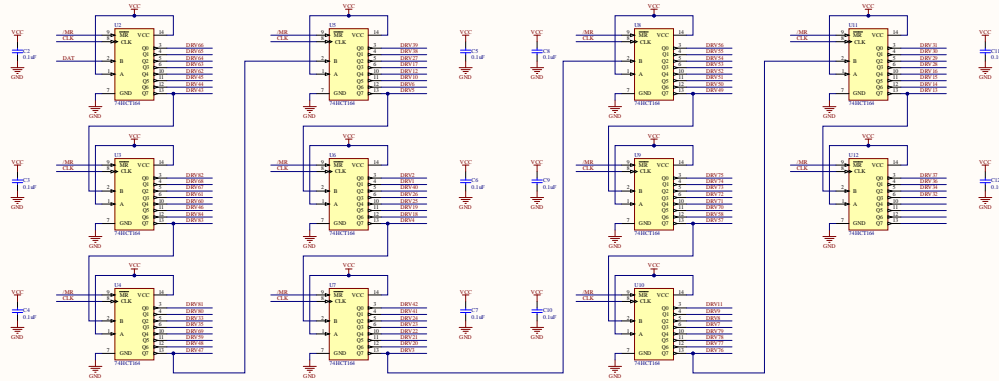
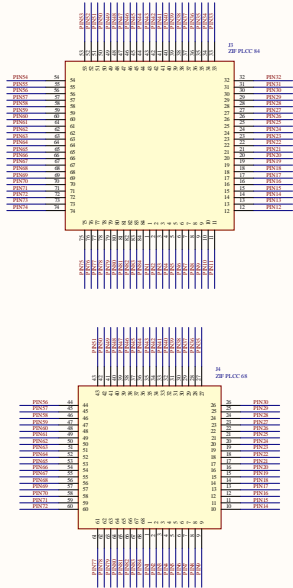
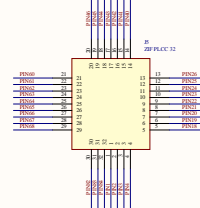
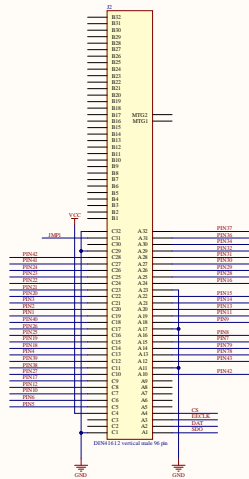
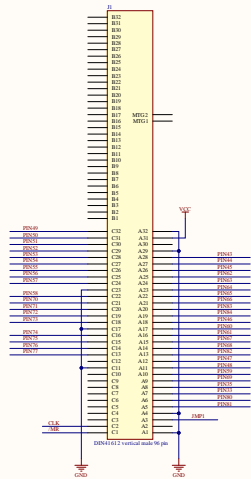

NOTE: 014 024 shared with other 014/024

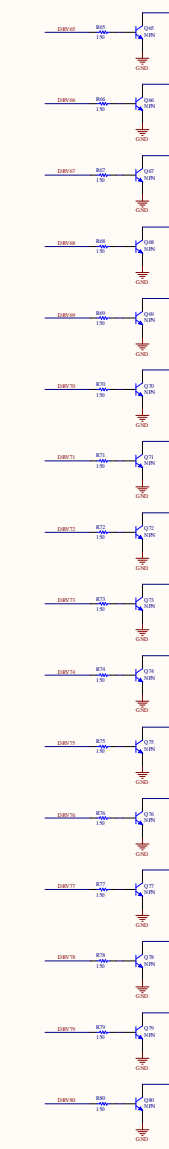
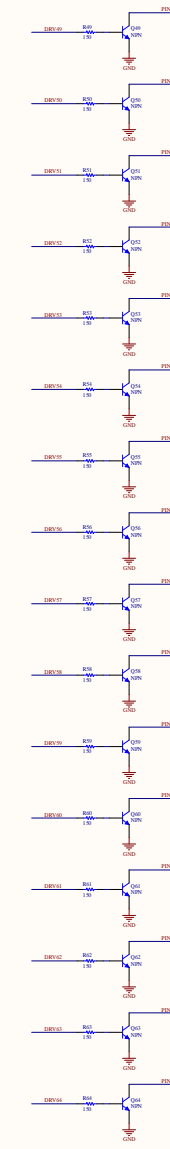
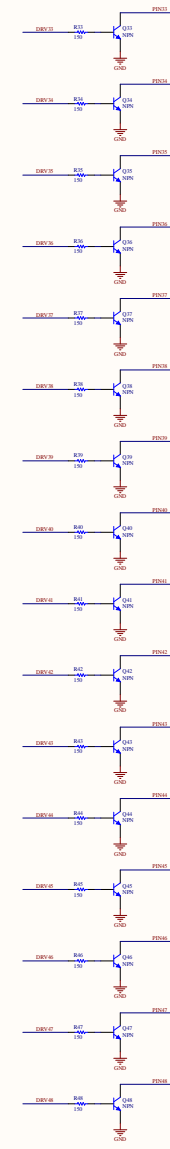
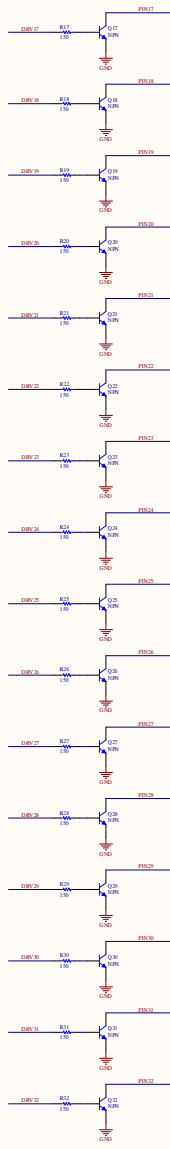
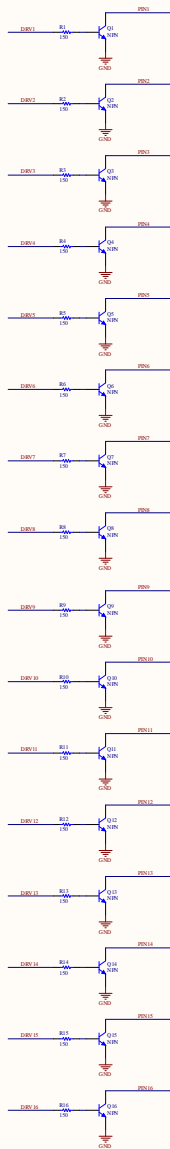

Transistors are MMBT402 or 9013 version, 2N4401 or 9713 version